

# Benefits and tradeoffs of application-specific WAN acceleration in different bandwidth, latency and loss scenarios.

Dirk-Jan van Helmond, Marc Smeets

*Research Report for MSc in System and Network Engineering  
July 5th, 2006*

# Agenda

- IT trends and inner-workings of WX and AppFlow
- Considerations of protocol optimization
- Test lab and lab considerations
- Tests performed
- Test results
- Difficulties of the WX platform
- Conclusion of results

# IT trends

- Centralization of services (e.g. email, storage)
- Usage of LAN protocols over WAN links
  - Problem: different link characteristics

# Working of the WX

- 2x WX on both sides work as a black box
- Caching, Compression
- TCP Optimization
  - TCP window size
  - Bandwidth\*delay product
- Application Acceleration
  - CIFS, MAPI, HTTP

# Why application layer acceleration works

- CIFS, MAPI and HTTP
  - HTTP by pre-fetching objects
  - CIFS and MAPI by eliminating protocol inefficiencies (window size = 1)

# No acceleration

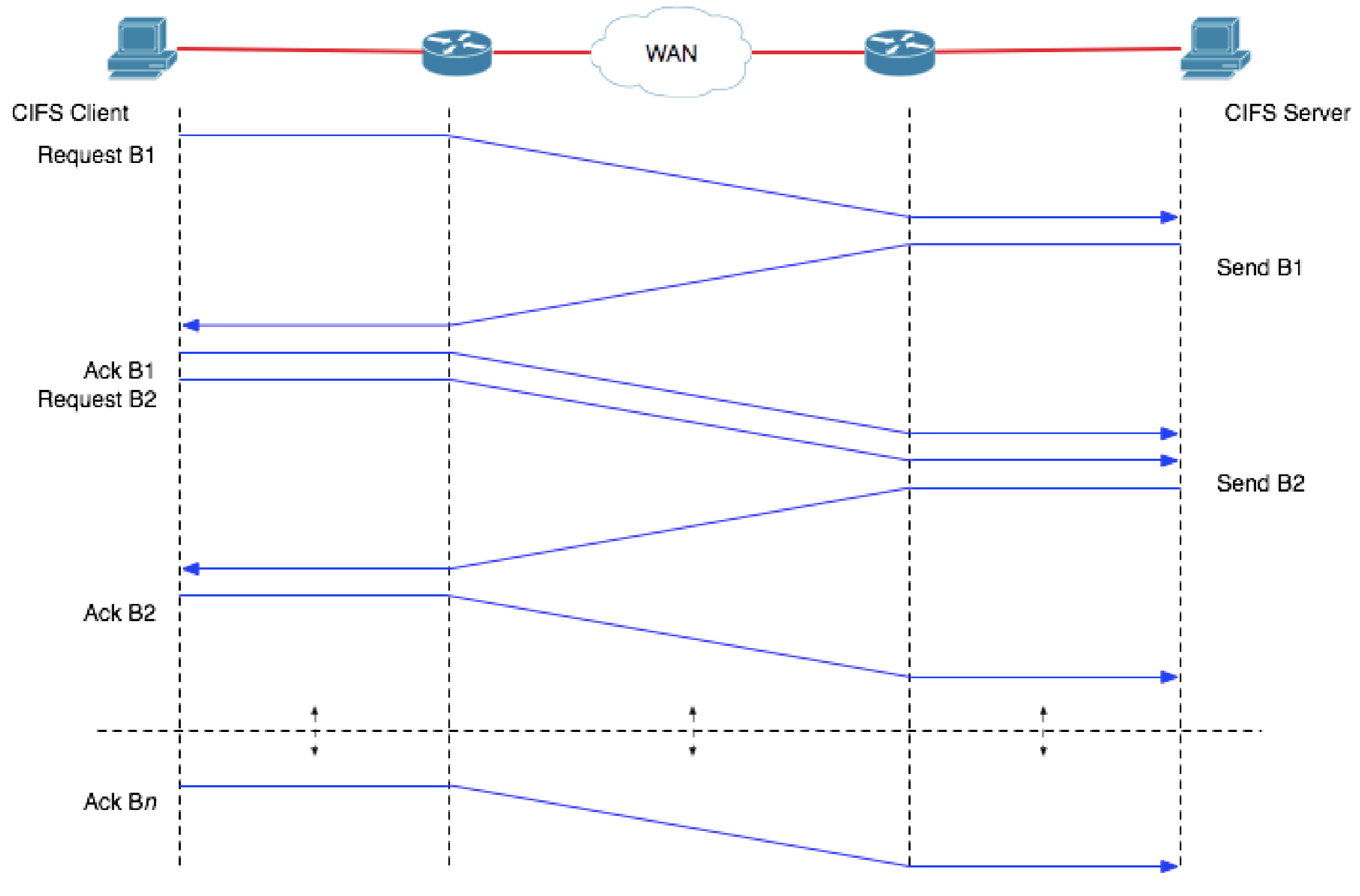

# AppFlow Acceleration

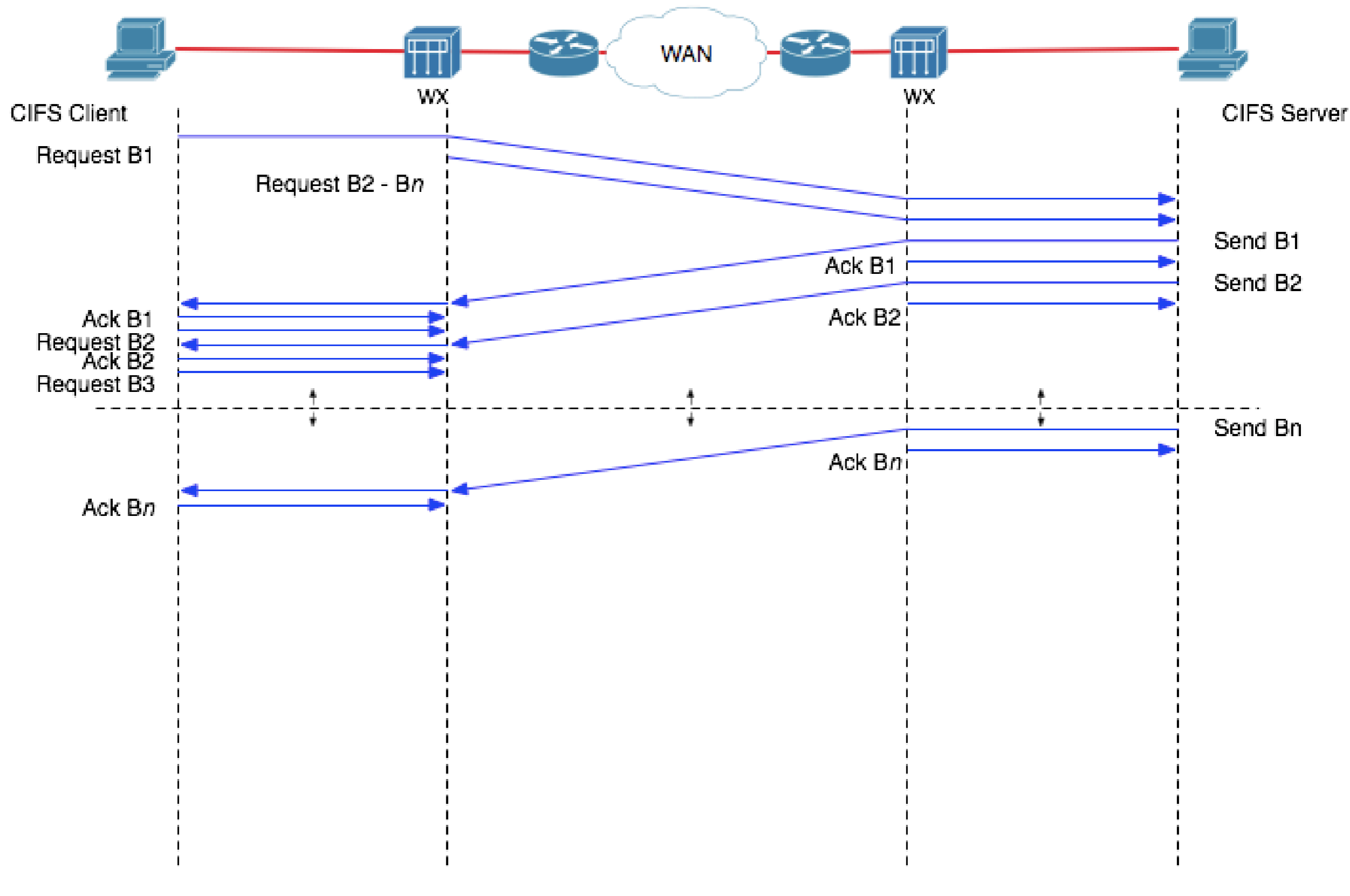

# Inline protocol optimization

- Vendors start to optimize their protocols
  - These products exist by grace of Microsoft
  - Otherwise Legacy/Niche market
- Total disregard of the OSI layered model
  - Choice: bad performance or rule breaking
  - Problems with troubleshooting/compatibility



# Expected scenario

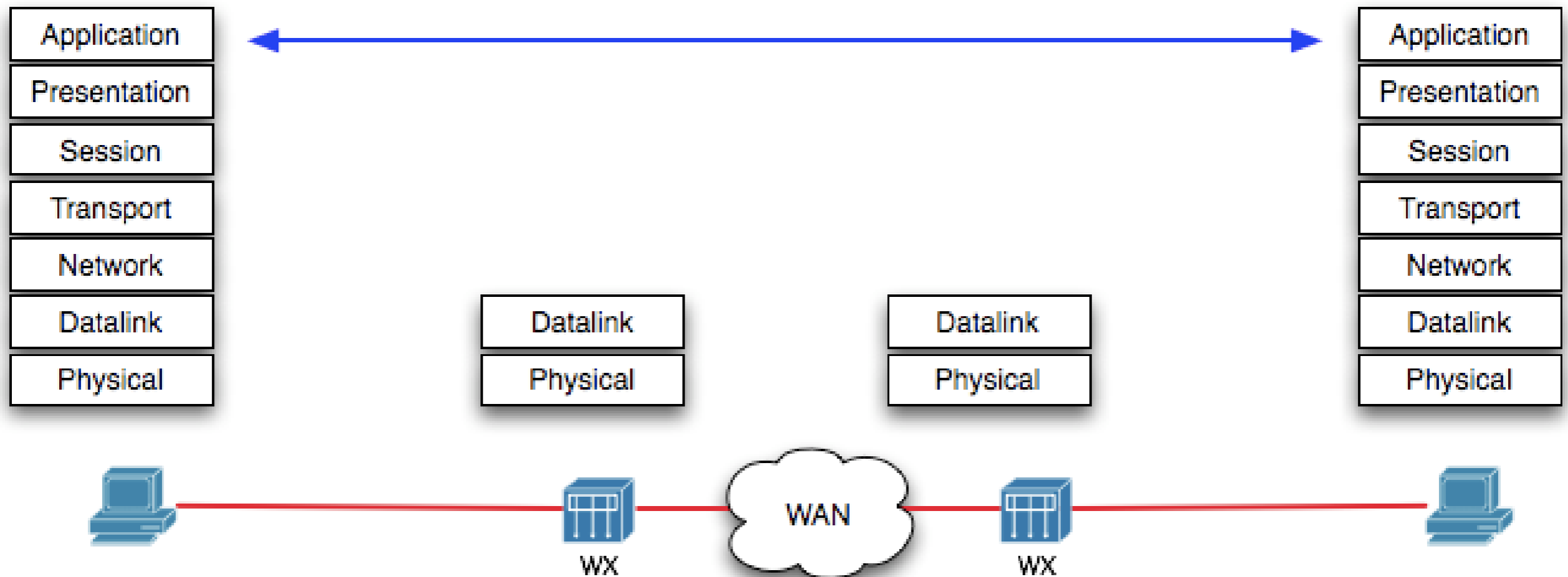

# Actual scenario

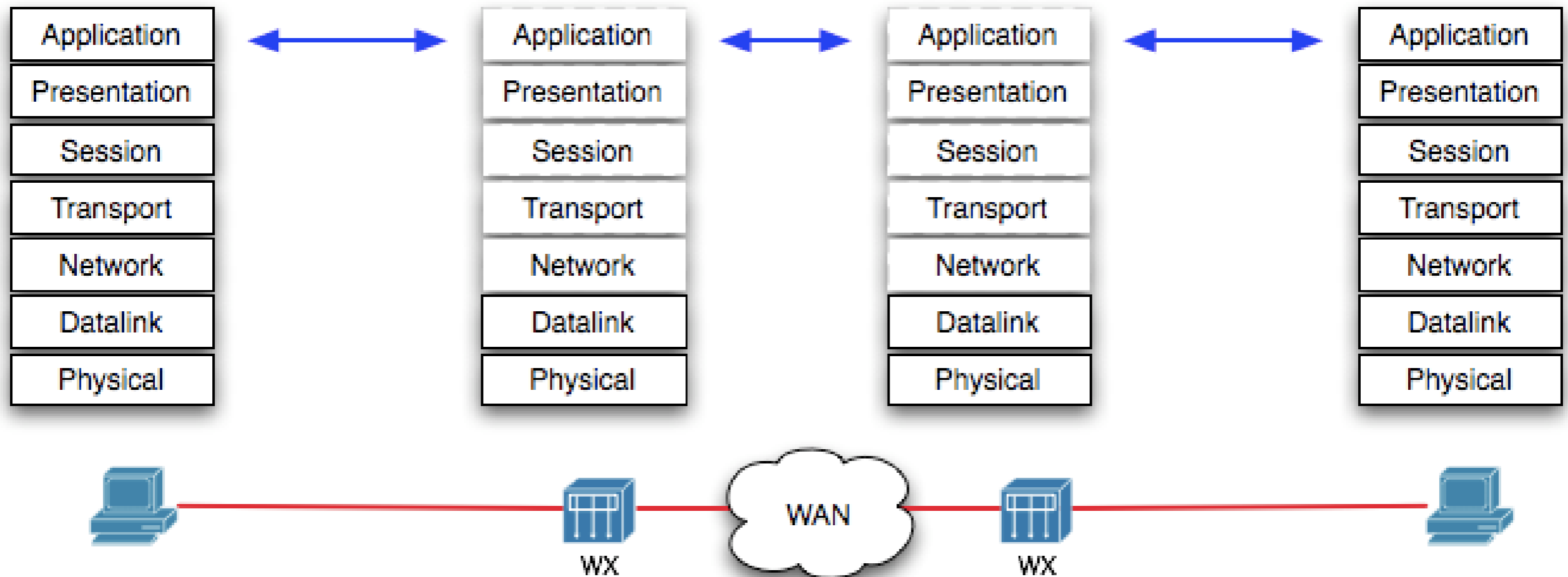

# Test lab

- 2x Juniper WX 250 Appliances
- 1x Windows 2003 File and Exchange Server
- 1x Windows XP client with Outlook
- 1x FreeBSD router
- 1x FreeBSD Link simulator (dummynet)
- 1x FreeBSD sniffer (tcpdump on a spanport)

# Test Setup

Management LAN : 10.0.0.0/24 and 11.0.0.0/24

Test LAN 'Main' Site: 192.168.0.0/24

Test LAN 'Remote' Site: 192.168.1.0/24

RS232 Management Interface

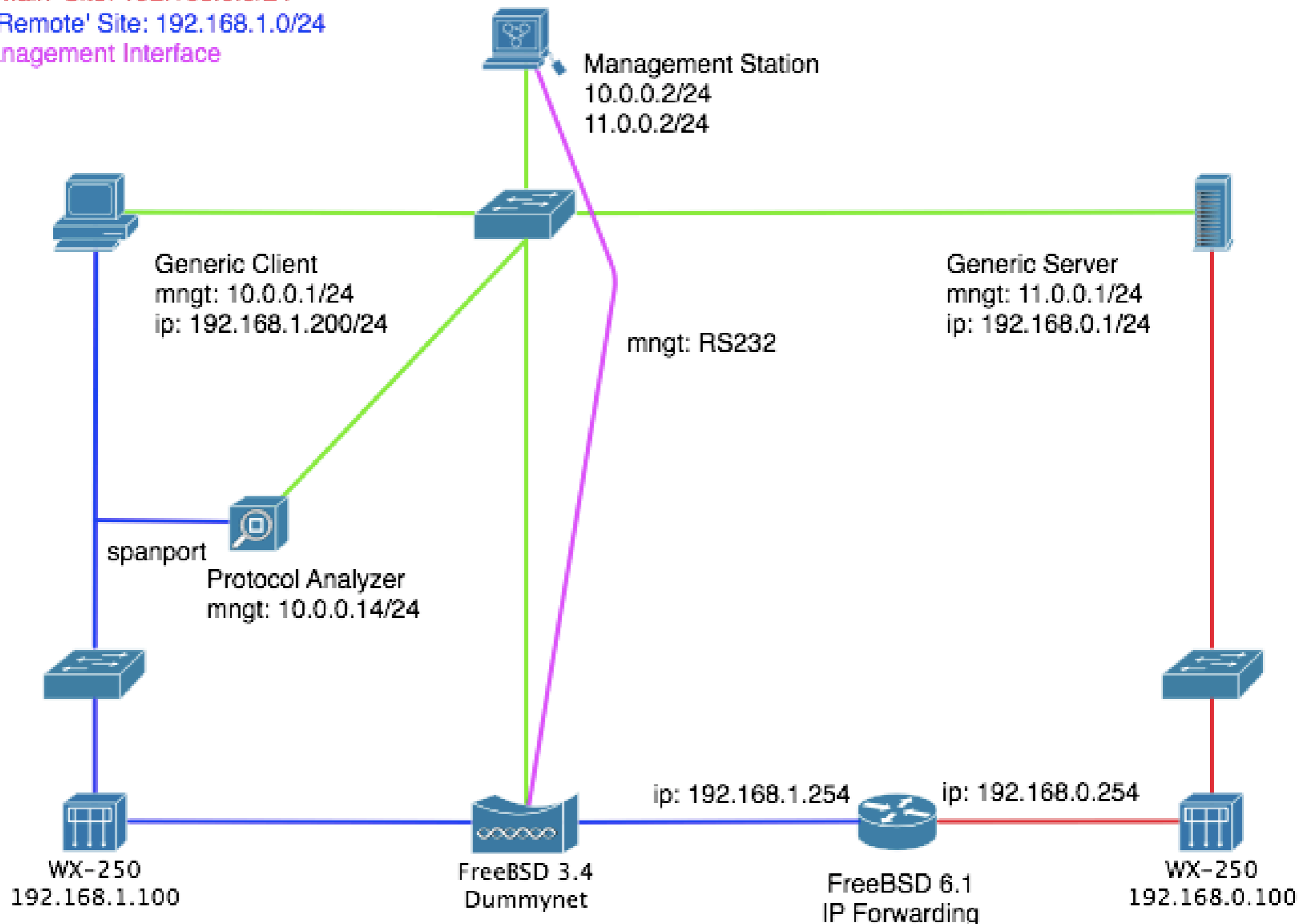

# Considerations

- Keeping the link clean
  - All management out of band
  - Disabled all unused protocols
- Empirical testing
  - Measurement by observation through packet inspection
  - Anomalies and unexplainable results marked, not investigated due to limited time

# Measurement

- Products of the equation
  - Volume is a known constant
  - Time needed for throughput measurement
- Time measured with protocol inspector
  - $\Delta t$  of first block and last block

# Measurement (cont'd)

- Interested in AppFlow acceleration
- No caching and compression
  - Files used are random binaries
- Two tests to differentiate between TCP optimization and AppFlow acceleration

# Tests done

- Baseline of no acceleration of any kind
- TCP yes, compression no
- CIFS
- MAPI XP
- MAPI 2003 (not yet fully supported by WX)
- Error correction



# Link scenarios

- Bandwidth:
  - T1 like speed = 1,544 Mbit/sec
  - OC-1 like speed = 51,84 Mbit/sec
- Delay (one-way):
  - 0 ms = local link
  - 30 ms = national link
  - 100 ms = transatlantic link
  - 250 ms = satellite link

# Testing CIFS

- Configure WX, reboot, mount share, open share in new window
- Configure WX, start tcpdump, ping, file transfer, ping close tcpdump
- Open PCAP, note time SMB offset 0 and last offset, calculate time and throughput

# Testing MAPI

- Configure WX, mail enough 10MB files, disable preview pane, reboot
- Configure WX, open mail, start tcpdump, ping, save-as, ping, stop tcpdump, close mail
- Open PCAP, note time first and last RPC, calculate time and throughput

# Testing loss

- Take scenarios tested that might be interesting
- configured chances of loss:
  - 0,1 0,05 0,01 0,005 0,001
- Do the exact same way of testing

# Test results

- CIFS TI & OC-I
- MAPI (XP) TI & OC-I
- MAPI (2003) TI & OC-I
- Loss:
  - CIFS OC-I, 0 ms
  - MAPI (XP) OC-I, 0 ms
  - MAPI (XP) OC-I, 250 ms

### Throughput CIFS T1

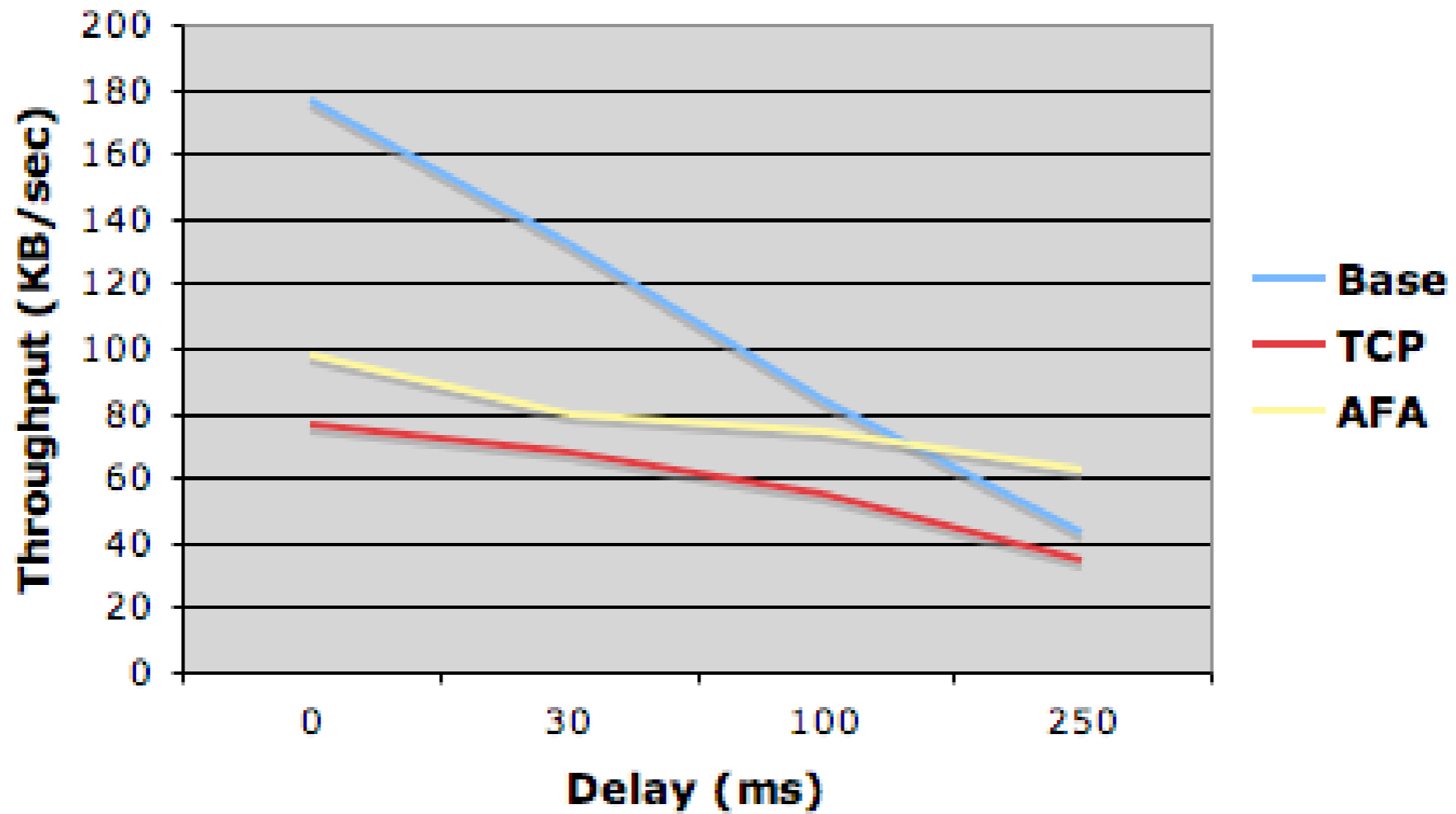

Delay	Base	TCP	AFA	Benefit
0ms	176,6	76,5	97,5	- 44.7%
30ms	131,8	67,8	79,4	- 39.7%
100ms	83,6	54,6	73,7	- 11.7%
250ms	42.7	34,2	62	45.4%

**Throughput of CIFS OC-1**

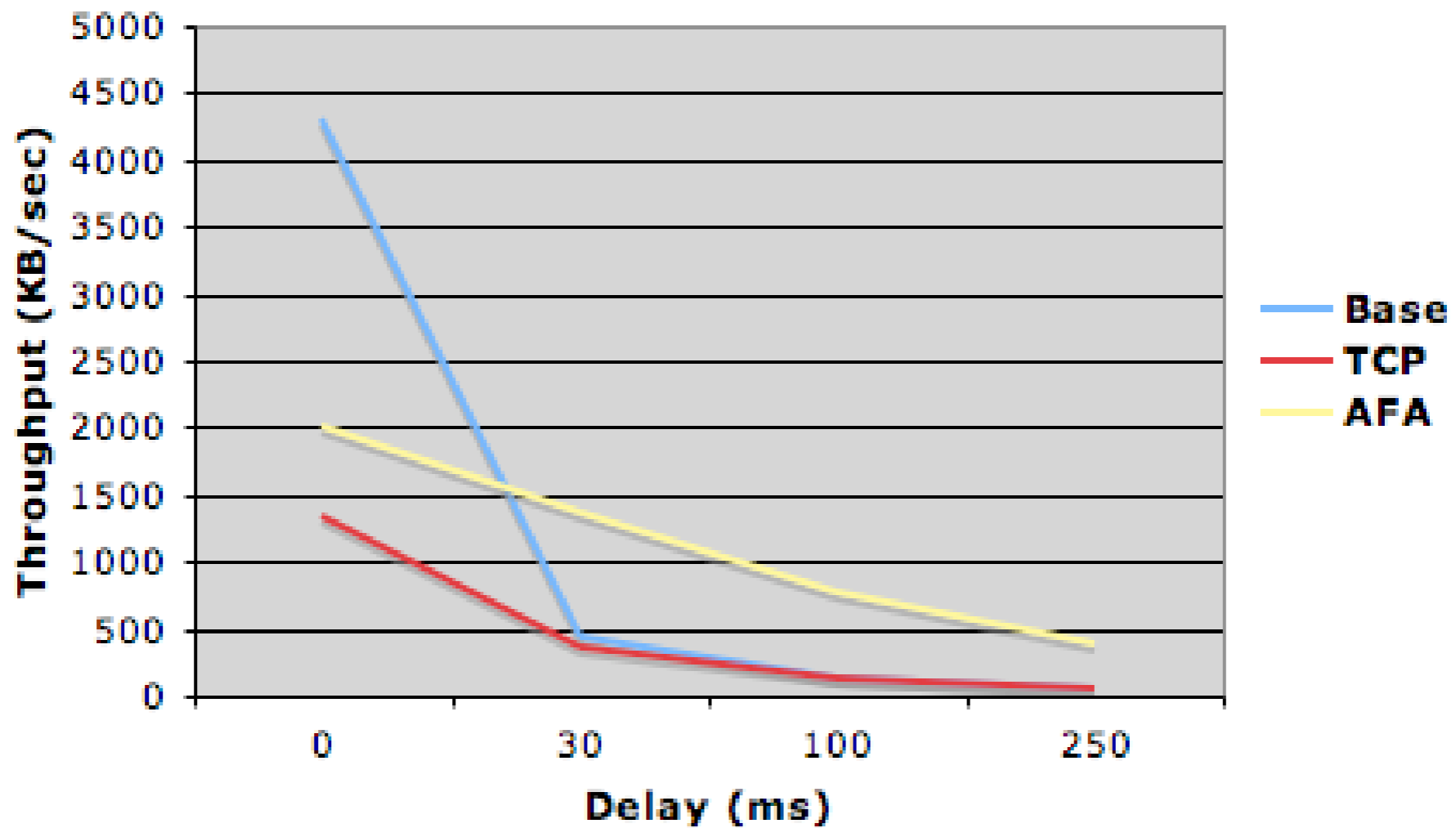

<b>Delay</b>	<b>Base</b>	<b>TCP</b>	<b>AFA</b>	<b>Benefit</b>
<b>0ms</b>	4294.6	1347,6	2008,7	- 53.2%
<b>30ms</b>	425,4	357,6	1373,4	222.8%
<b>100ms</b>	126,1	139,5	774,7	514.3%
<b>250ms</b>	52,3	59,7	375,4	617.4%

**Throughput MAPI (XP) T1**

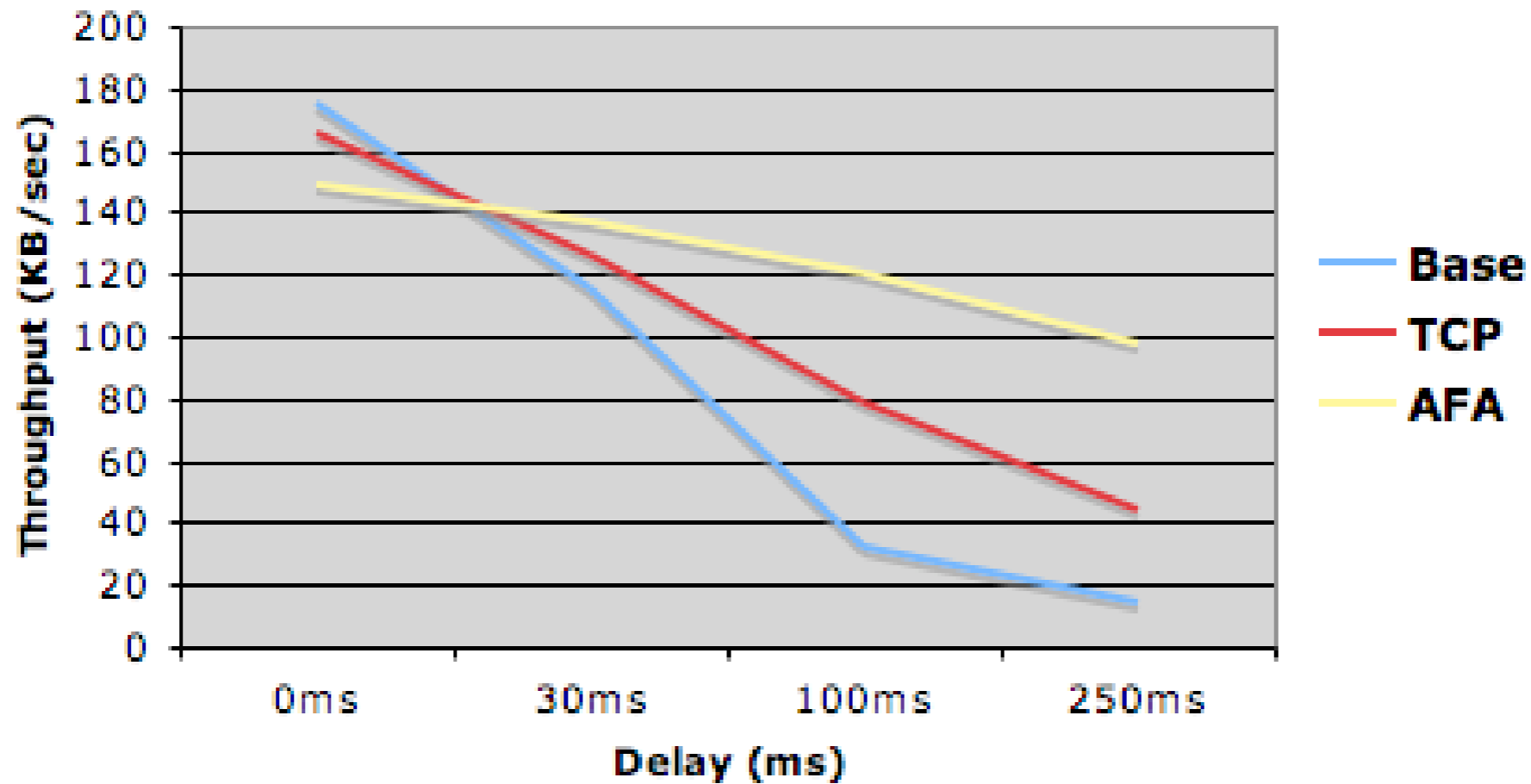

<b>Delay</b>	<b>Base</b>	<b>TCP</b>	<b>AFA</b>	<b>Benefit</b>
<b>0ms</b>	175.1	165.7	148.9	- 14.9%
<b>30ms</b>	116.0	126.1	136.7	17.9%
<b>100ms</b>	32.1	78.8	120.1	274.1%
<b>250ms</b>	14.3	44.1	98.2	585.7%



### Throughput MAPI (XP) OC-1

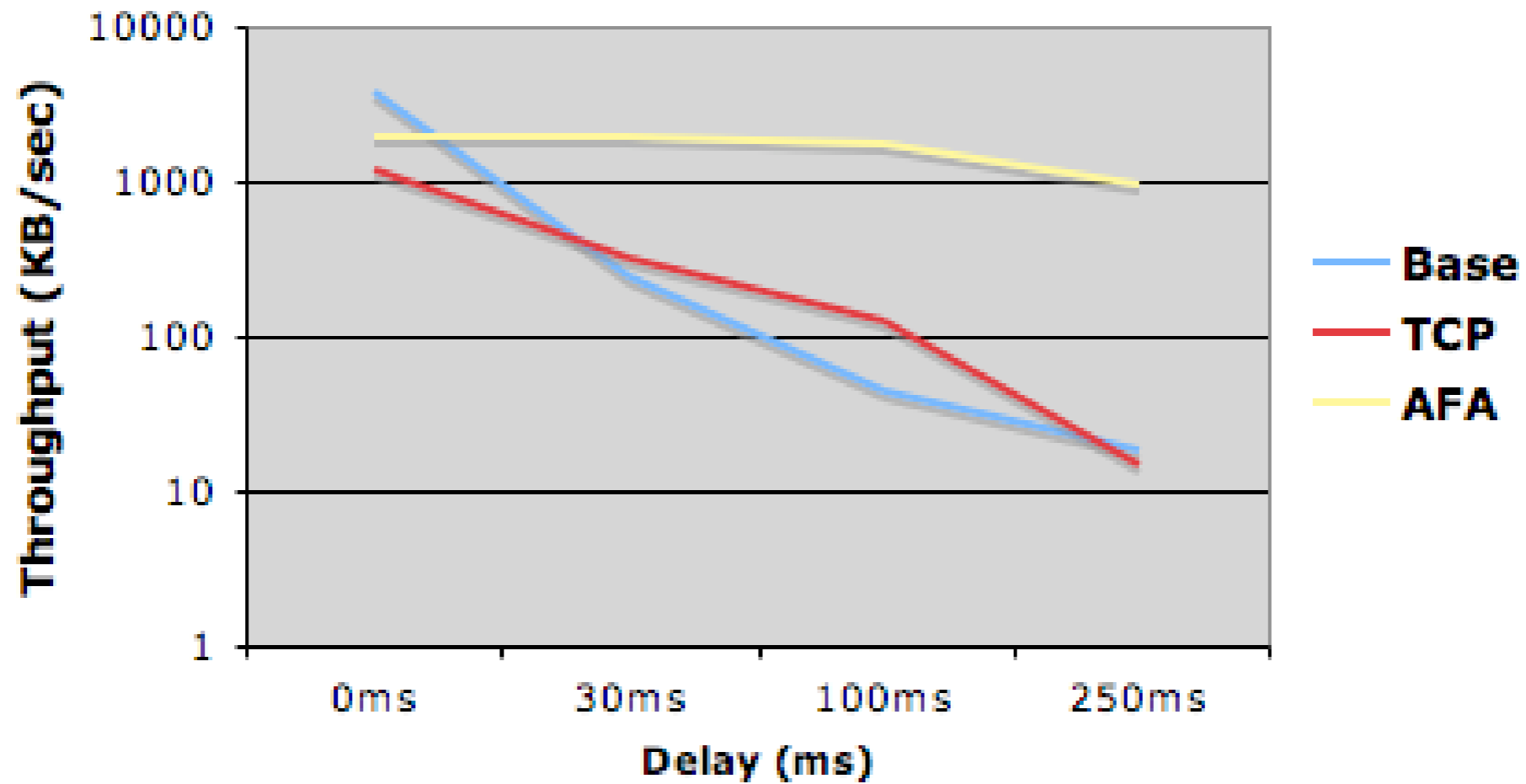

Delay	Base	TCP	AFA	Benefit
0ms	3688,3	1191,4	<u>1969,9</u>	- 46.6%
30ms	243,9	320,4	<u>1949,9</u>	652.5%
100ms	44,3	126,2	<u>1706,2</u>	3752.9%
250ms	17,9	15	953,6	5205.5%

**Throughput MAPI (2003) T1**

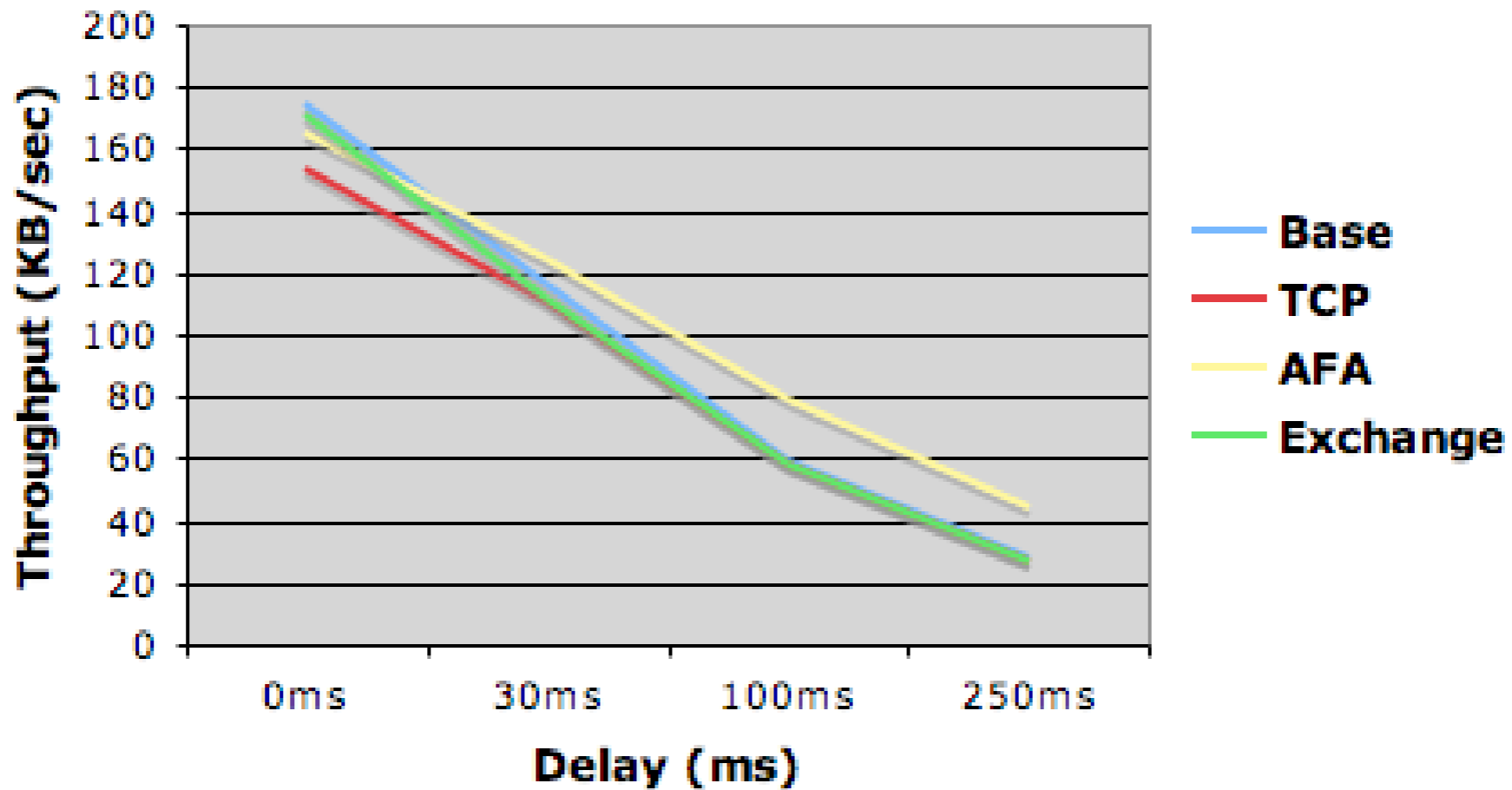

Delay	Base	TCP	AFA	Benefit	Exchange	Benefit
0ms	174	153,8	164,9	- 5.2%	170,8	- 1.8%
30ms	116,1	110,1	124,5	7.2%	111,7	- 3.8%
100ms	59,1	57,8	79,4	34.3%	58,7	- 0.9%
250ms	27,7	26,4	44,5	60.5%	27,2	- 1.8%

**Throughput MAPI (2003) OC-1**

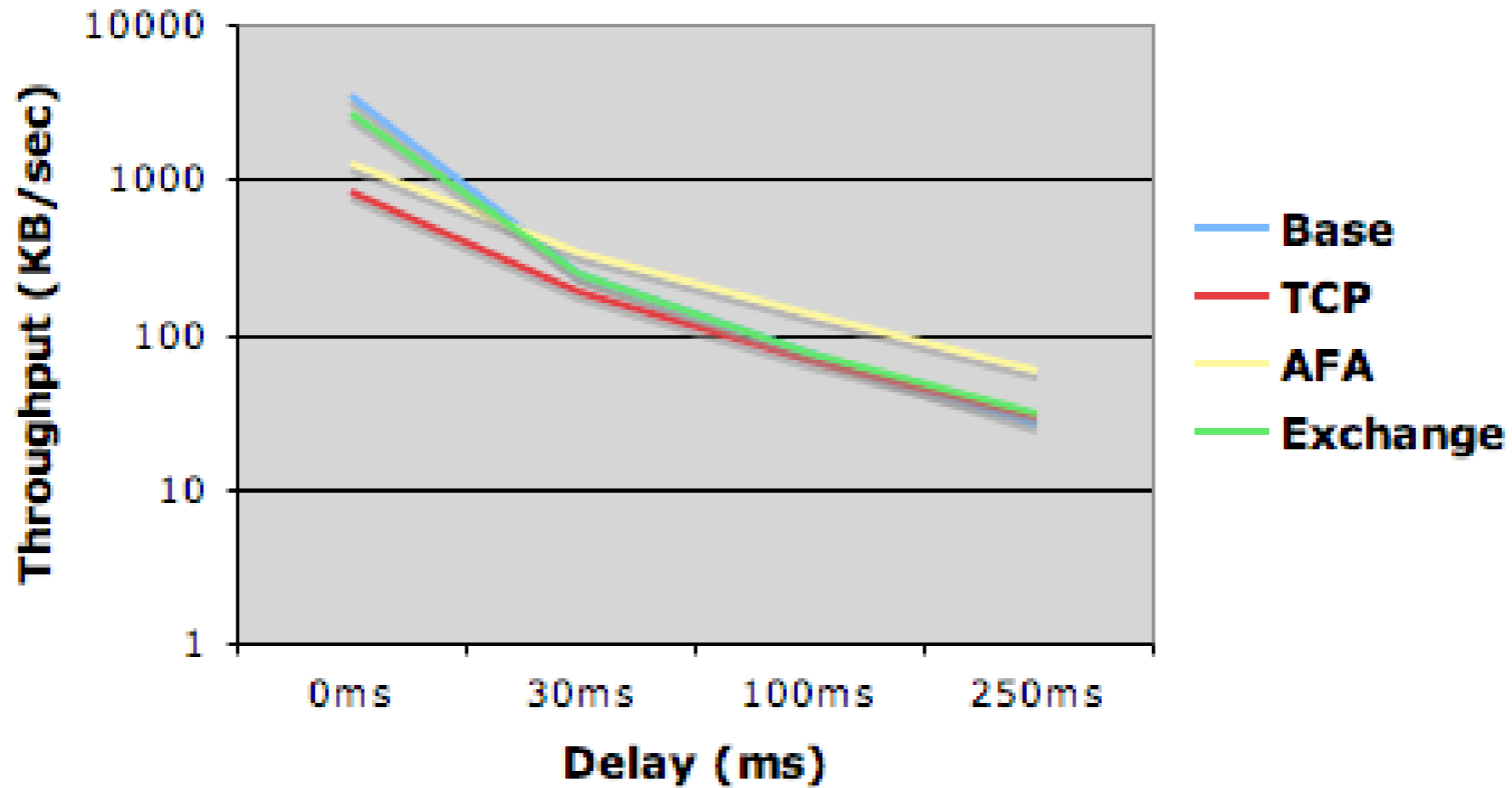

Delay	Base	TCP	AFA	Benefit	Exchange	Benefit
0ms	3447,1	829,6	1234,4	- 64.2%	2600,4	- 24.6%
30ms	244,9	183,3	337,8	37.9%	243,4	- 0.6%
100ms	72,8	68,8	131,2	80.1%	74,5	2.3%
250ms	25,5	28,7	57,8	125.9%	29,9	17.2%

### CIFS OC-1 0ms

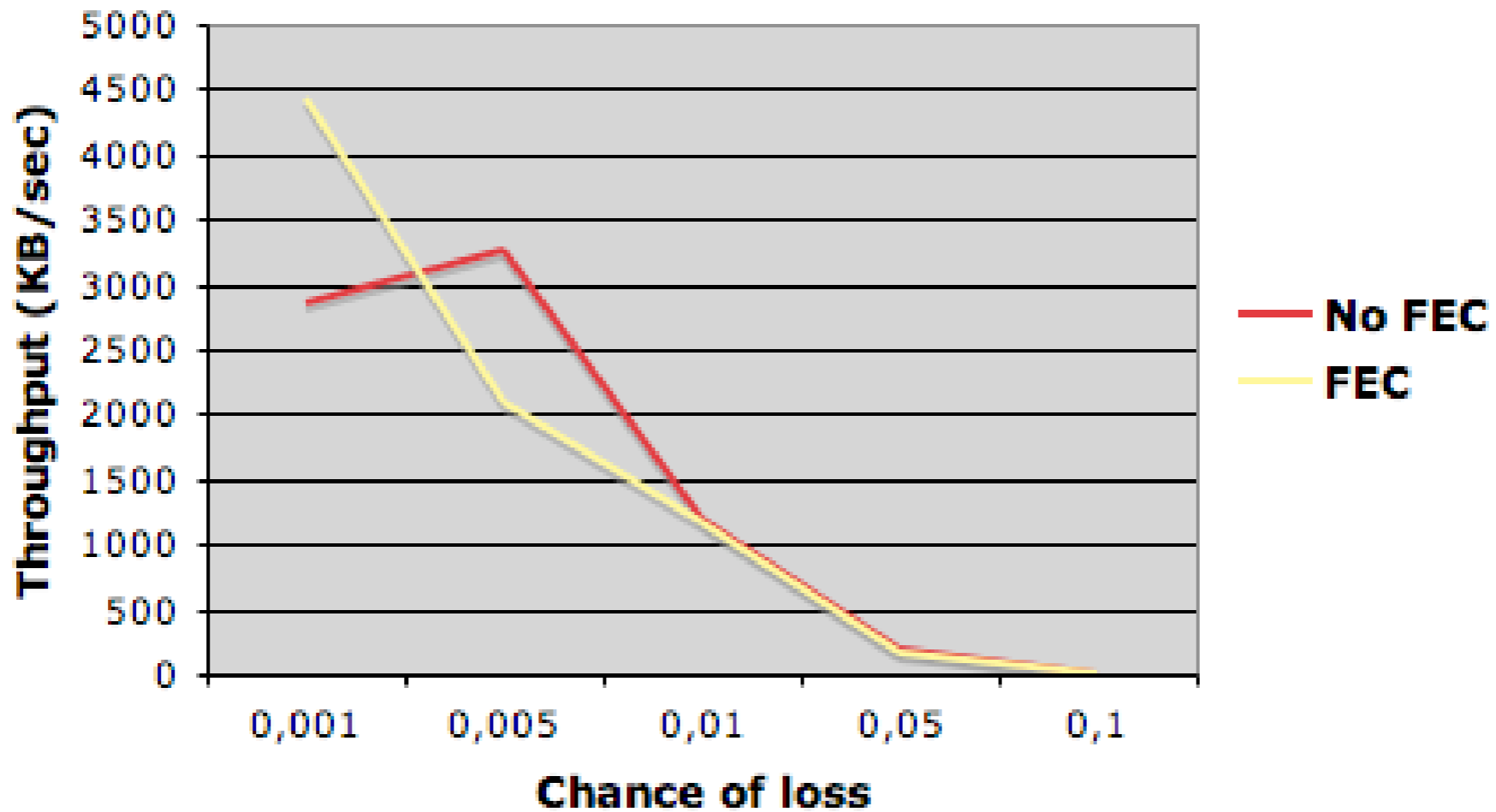

	<b>0,001</b>	<b>0,005</b>	<b>0,01</b>	<b>0,05</b>	<b>0,1</b>
<b>No FEC</b>	2856,01	3263,278	1202,849	190,276	0
<b>FEC</b>	4417,992	2090,559	1159,407	152,972	0
<b>Benefit</b>	54.7%	- 36.0%	- 3.6%	- 19.6%	-

**MAPI (XP) OC-1 0ms**

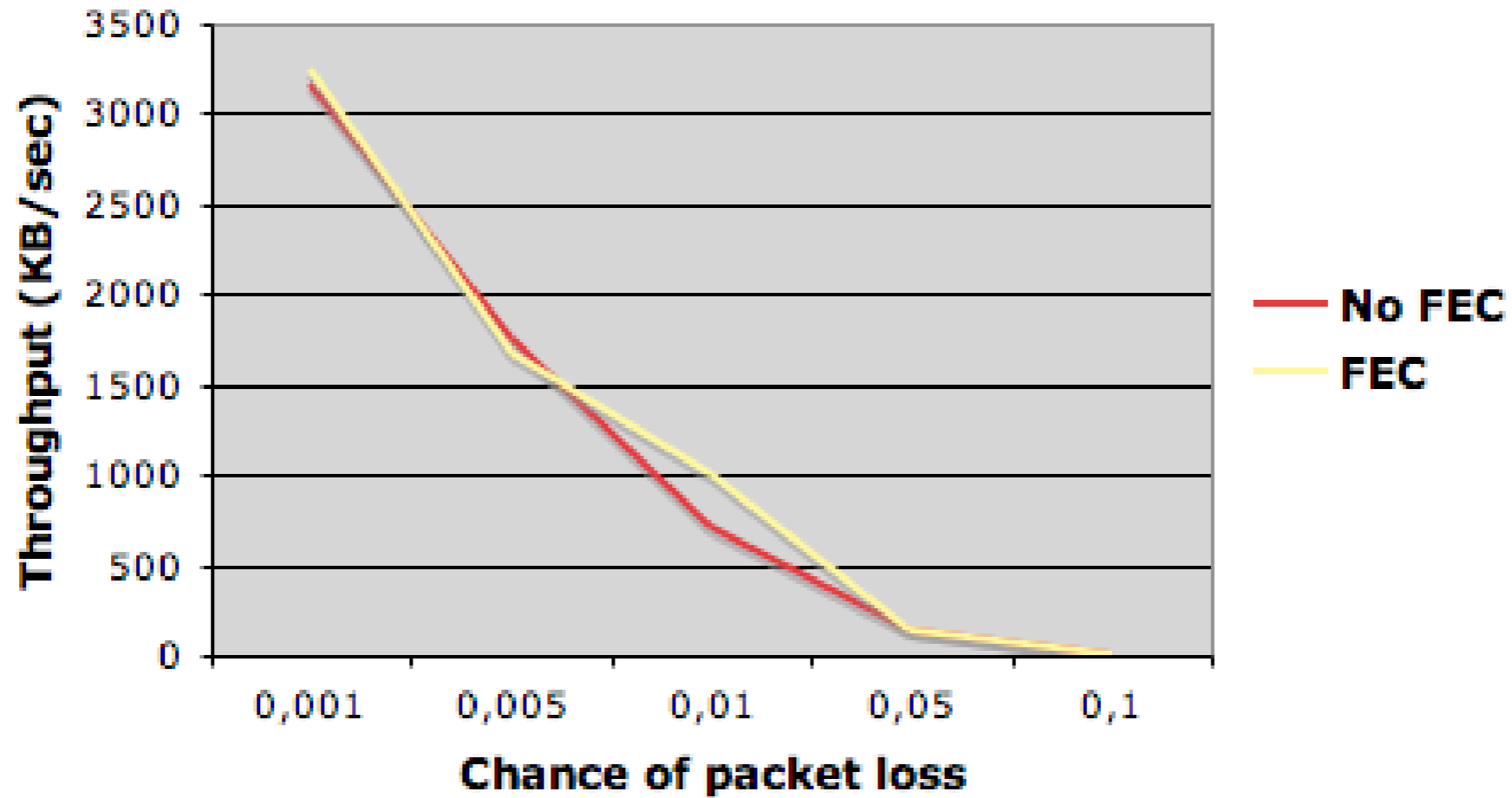

	<b>0,001</b>	<b>0,005</b>	<b>0,01</b>	<b>0,05</b>	<b>0,1</b>
<b>No FEC</b>	3175,211	1752,428	715,445	134,71	0
<b>FEC</b>	3253,187	1671,632	1008,115	131,317	0
<b>Benefit</b>	<b>2.5%</b>	- 4.6%	<b>40.9%</b>	- 2.5%	-

**MAPI (XP) OC-1 250ms**

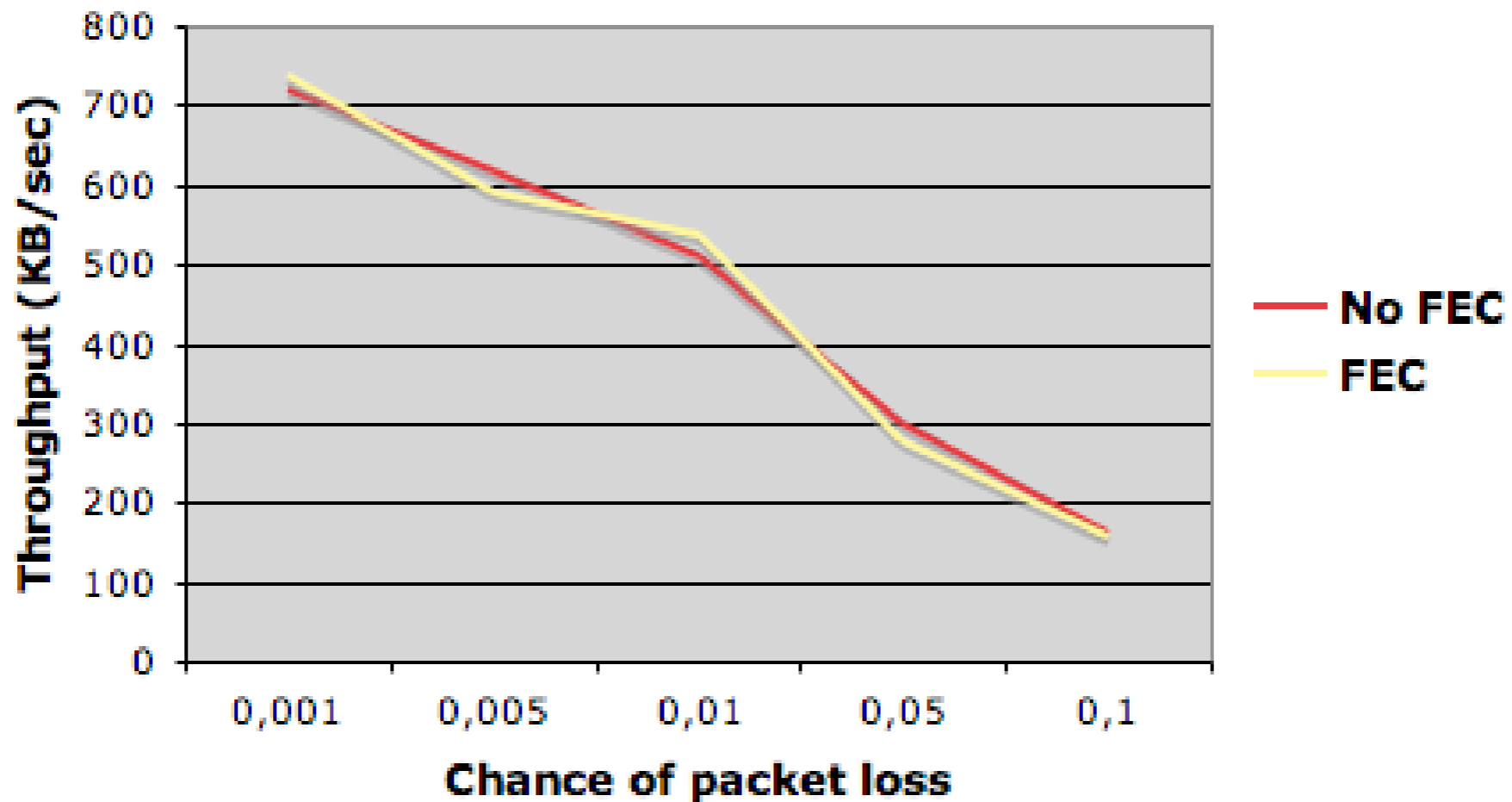

	<b>0,001</b>	<b>0,005</b>	<b>0,01</b>	<b>0,05</b>	<b>0,1</b>
<b>No FEC</b>	718,665	618,808	511,205	299,471	162,352
<b>FEC</b>	735,539	587,953	534,195	277,04	155,296
<b>Benefit</b>	<b>2.3%</b>	- 5.0%	<b>4.5%</b>	- 7.5%	- 4.3%

# Conclusion

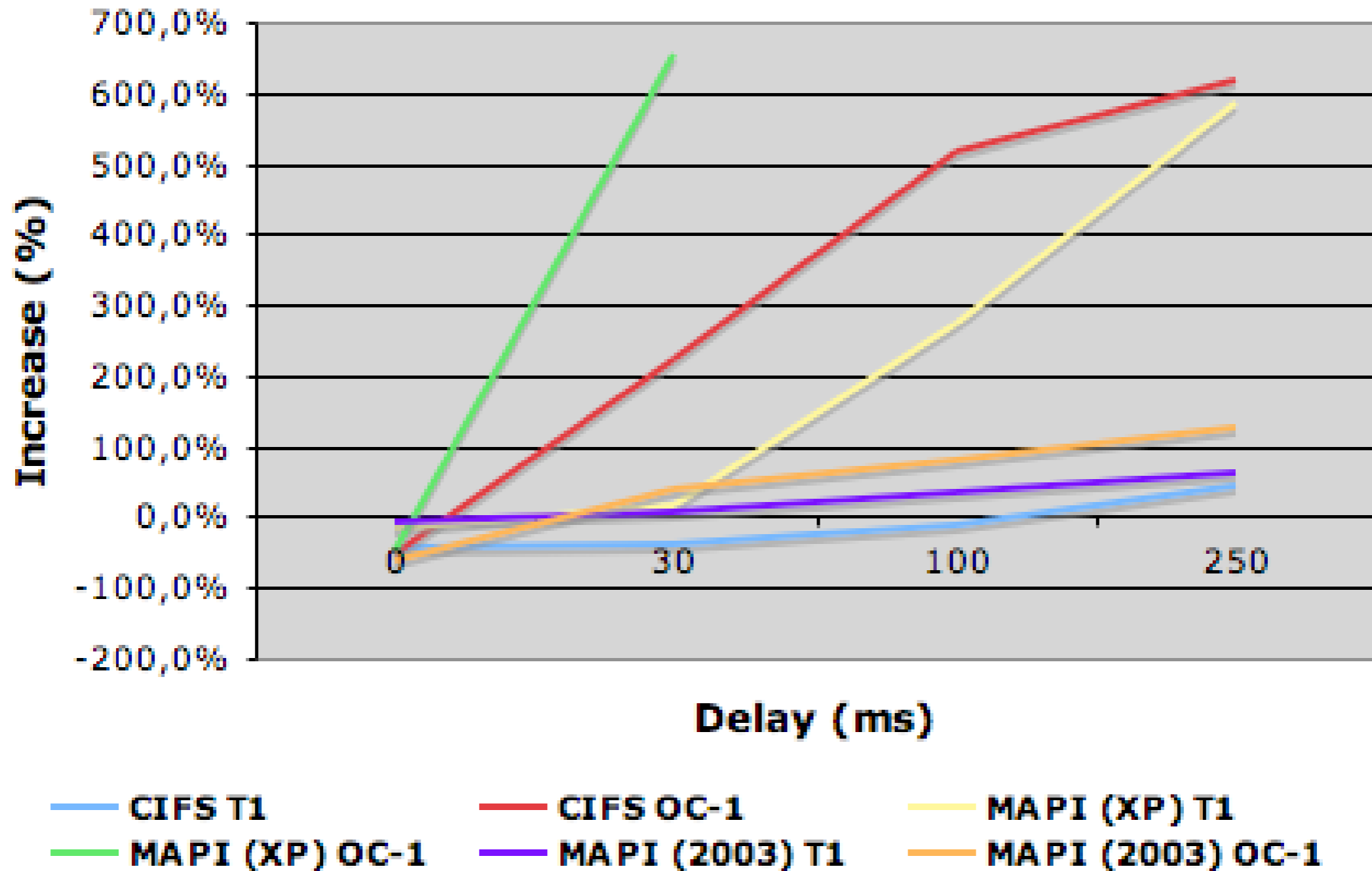

# Conclusion MAPI 2003

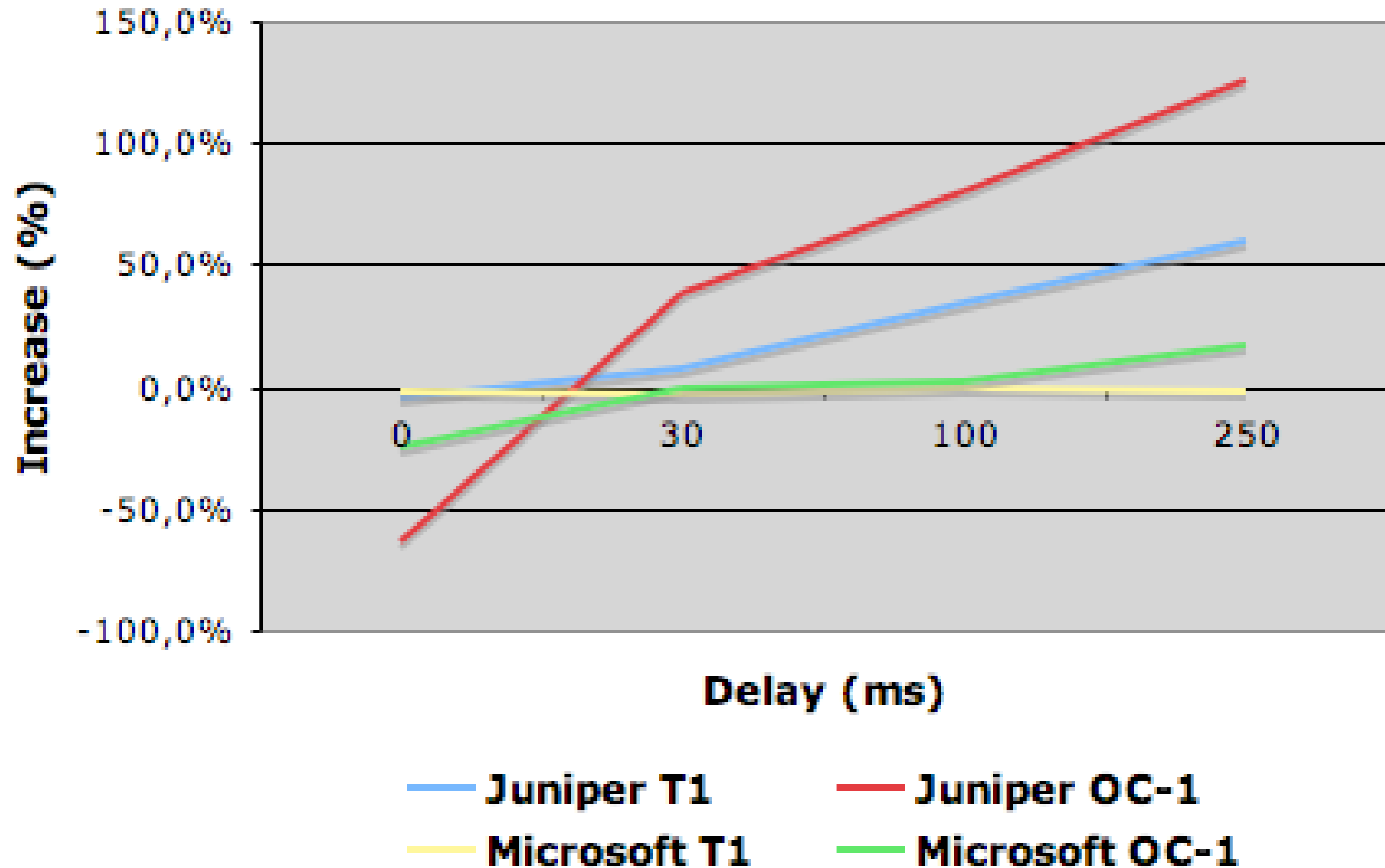



# Final Conclusion

- Very good performance of CIFS, MAPI acceleration
- Better acceleration than Microsoft with Exchange 2003
- No significant performance increase FEC
- Disregard of the OSI layered model

# Questions

